

## GV-VD1540-E 1.3MP H.264 3x zoom Super Low Lux WDR IR Arctic Vandal Proof

### IP Dome



- 1/3" progressive scan super low lux CMOS
- Minimum illumination at 0.01 lux
- Dual streams from H.264 and MJPEG
- Up to 30 fps at 1280 x 1024
- Vandal resistance (IK10+)
- Ingress protection (IP67)
- Wide temperature tolerance (-40°C ~ 50°C / -40°F ~ 122°F)
- Motorized varifocal lens for remote focus/zoom adjustment
- 3-axis mechanism (pan / tilt / roll)
- Removable IR-cut filter for Day/Night function
- High power IR LEDs
- Intelligent IR
- IR distance up to 30 m (98.4 ft.)
- External microphone
- 2-way audio
- One sensor input and alarm output
- TV-out support
- Built-in micro SD card slot (SD/SDHC) for local storage
- DC12V / AC24V / PoE
- Wide Dynamic Range (WDR)
- 3D DNR (Digital Noise Reduction)
- Defog
- Motion detection
- Tampering alarm
- Privacy mask
- IP address filtering
- Supports iPhone, iPad, Android & 3GPP
- 31 languages on Web interface
- ONVIF (Profile S) conformant

\*No Memory card slot & local storage function for Argentina.

### Active Tampering Alarm

Tampered



Focus Change



Camera Shift



### Introduction

GV-VD1540-E is an outdoor camera designed with IK10+ vandal resistance, IP67 ingress protection and tolerance to extreme temperatures. With its motorized varifocal lens, the user can zoom and focus the camera from the Web interface. The camera is equipped with a super low lux CMOS image sensor with which the camera is capable of providing a color live view in near darkness. This night vision is further enhanced with its high power LEDs with up to 30 m (98.4 ft.) effective distance.

**Overview**



**Dimensions**

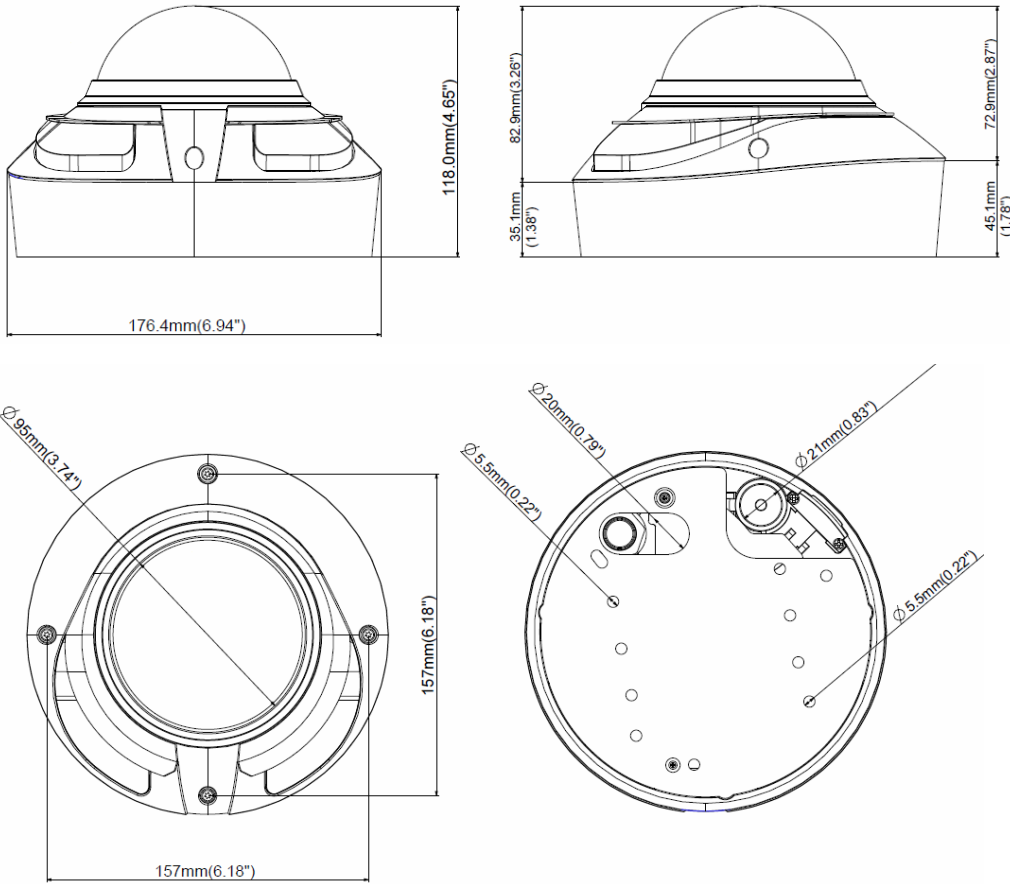

## Specifications

Camera		
Image Sensor	1/3" progressive scan super low lux CMOS	
Picture Elements	1280 (H) x 1024 (V)	
Minimum Illumination	Color	0.01 Lux
	B/W	
	IR ON	0 Lux
Shutter Speed	Automatic, Manual (1/5 ~ 1/8000 sec.)	
White Balance	Automatic, Manual (2800K ~ 8500K)	
Gain Control	Automatic	
S/N Ratio	55 dB	
WDR	Yes	
Lens		
Megapixel	Yes	
Day / Night	Yes (with removable IR-cut filter)	
Lens Type	Motorized varifocal lens	
Focal Length	3 ~ 9 mm	
Maximum Aperture	F/1.2	
Mount	Ø 14 mm	
Image Format	1/2.7"	
Operation	Focus	Auto Focus
	Zoom	3X Optical Zoom
	Iris	DC drive
Max. Torque (Focus/ Zoom Screws)	0.049 N.m	
High Power IR LED Quantity	6 IR LEDs	
Max. IR Distance	30 m (98.4 ft.)	
Operation		
Video Compression	H.264, MJPEG	
Video Stream	Dual streams from H.264 and MJPEG	
Frame Rate	30 fps at 1280 x 1024 * The frame rate and the performance may vary depending on the number of connections and data bitrates (different scenes).	
Image Setting	Brightness, Contrast, Sharpness, Gamma, White Balance, Flicker-less, Image Orientation, Backlight Compensation, D/N Sensitivity, Shutter Speed, WDR, Defog, Super Low Lux, Zoom, Focus Change	
Audio Compression	G.711	
Two-way Audio	Yes	
Sensor Input	1 Input (Dry Contact)	
Alarm Output	1 Output (200mA 5V DC)	
Video Resolution		
Main Stream	4:3	1280 x 960, 640 x 480, 320 x 240
	16:9	1280 x 720, 640 x 360, 448 x 252
	5:4	1280 x 1024, 640 x 512, 320 x 256
Sub Stream	4:3	640 x 480, 320 x 240
	16:9	640 x 360, 448 x 252
	5:4	640 x 512, 320 x 256
Network		
Interface	10/100M Ethernet	
Ethernet Protocol	DHCP, DynDNS, FTP, HTTP, HTTPS, NTP, ONVIF (Profile S), PSIA, QoS (DSCP), RTSP, SNMP, SMTP, TCP, UDP, UPnP, 3GPP/ISMA	
Mechanical		
Temperature Detector	Yes	
Camera Angle Adjustment	Pan	-90° ~ 90°
	Tilt	0° ~ 85°
	Rotate	0° ~ 350°
Connectors	Power	2-pin terminal block, PoE
	Ethernet	Ethernet (10/100 Base-T), RJ-45 cable
	Audio	1 In (3.5mm phone jack for microphone) 1 Out (3.5mm phone jack for speaker)

Connectors	Digital I/O	3-pin terminal block, pitch 2.5 mm (0.1")
	Auto Iris	DC drive
	Local Storage	Micro SD card slot (SD/SDHC, SD version 2.0 only, Class 10) * <b>SDXC</b> and <b>UHS-I</b> card types are not supported.
	TV-Out	BNC connector (640 x 480 resolution)
LED Indicator	2 LEDs: Power, Status	
<b>General</b>		
Environment Temperature	Start-up	-40°C ~ 50°C (-40°F ~ 122°F)
	Operation	
Humidity	10% to 90% (no condensation)	
Power Source	12V DC / 24V AC / PoE+ 802.3at	
Max. Power Consumption	30 W	
Dimensions	Camera Body	ø 176.5 x 118 mm (6.9" x 4.6")
Weight	1.83 kg (4.03 lb)	
Heater On	On: 0°C (32°F) Off: 1°C (33.8°F)	
Fan	Constantly on	
Ingress Protection	IP67	
Vandal Resistance	IK10+	
Regulatory	CE, FCC, RCM, RoHS compliant	
<b>Power over Ethernet</b>		
PoE Standard	IEEE 802.3at Power over Ethernet / PD	
PoE Power Supply Type	End-Span	
PoE Power Output	Per Port 48V DC, 600mA. Max. 30 watts	
<b>Web Interface</b>		
Installation Management	Web-based configuration	
Maintenance	Firmware upgrade through Web Browser or Utility	
Access from Web Browser	Camera Live View, Video Recording, Change Video Quality, Bandwidth Control, Image Snapshot, Digital I/O Control, Audio, Picture in Picture, Picture and Picture, Privacy Mask, Visual Automation, Tampering Alarm, Text Overlay, Digital PTZ	
Language	Arabic / Bulgarian / Czech / Danish / Dutch / English / Finnish / French / German / Greek / Hebrew / Hungarian / Indonesian / Italian / Japanese / Lithuanian / Norwegian / Persian / Polish / Portuguese / Romanian / Russian / Serbian / Simplified Chinese / Slovakian / Slovenian / Spanish / Swedish / Thai / Traditional Chinese / Turkish	
<b>Applications</b>		
Network Storage	GV-NVR, GV-System, GV-Backup Center, GV-Recording Server	
Smart Device Access	GV-Eye for Android smartphone, tablet, iPhone, and iPod Touch GV-Eye HD for iPad	
Live Viewing	IE, mobile phone	
CMS Server support	GV-Control Center, GV-Center V2, GV-VSM	

**Note:**







1. Do not use clothes or any ordinary material to clean the camera cover since they may result in scratches.
2. Specifications are subject to change without notice.

## Packing List

- |                         |                                      |
|-------------------------|--------------------------------------|
| 1. Vandal Proof IP Dome | 11. Long Screw x 4                   |
| 2. Torx Wrench          | 12. Flat Screw                       |
| 3. 3-Pin Terminal Block | 13. Short Screw x 2                  |
| 4. Audio Wires          | 14. Silica Gel Bag                   |
| 5. Power Adapter        | 15. Sticker (for Silica Gel Bag)     |
| 6. TV Out Wire          | 16. Ruler                            |
| 7. RJ-45 Connector x 2  | 17. GV-IPCAM H.264 Software CD       |
| 8. Back Plate           | 18. GV-IPCAM H.264 Quick Start Guide |
| 9. Installation Sticker | 19. GV-NVR Software DVD              |
| 10. Screw Anchor x 4    | 20. GV-NVR Quick Start Guide         |

## Accessories

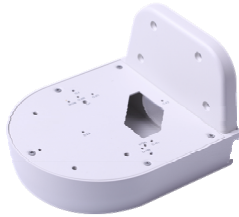
Model No.	Name		Details
GV-Mount100	Straight Tube and Junction Box Kit		Dimensions: 200 x 170 x 257.5 mm (7.9" x 6.7" x 10.1") Weight: 3.17 Kg (6.99 lb)
GV-Mount101	Straight Tube Kit		Dimensions: 219 x 125 x 332 mm (8.6" x 4.9" x 13.1") Weight: 1.8 Kg (3.97 lb)
GV-Mount200	Wall Pendant Tube		Dimensions: 225 x 140 x 250 mm (8.9" x 5.5" x 9.8") Weight: 900 g (1.98 lb)
GV-Mount203	Wall Pendant Tube and Junction Box Kit		Dimensions: 315 x 195.5 x 225 mm (12.4" x 7.7" x 8.9") Weight: 2.95 Kg (6.5 lb)
GV-Mount300	Convex Corner Adapter Kit		Dimensions: 238.6 x 409.5 mm (9.4" x 16.1") Weight: 4.27 Kg (9.41 lb)
GV-Mount310	Concave Corner Adapter Kit		Dimensions: 238.6 x 409.5 mm (9.4" x 16.1") Weight: 4.27 Kg (9.41 lb)

Model No.	Name		Details
GV-Mount400	Pole Mount Bracket Kit ( $\varnothing$ 4" ~ 6")		<p>Dimensions</p> <p>Bracket: 241 x 161 mm (9.5" x 6.3")</p> <p>Weight: 1.70 Kg ( 3.75 lb)</p> <p>Steel Strap Diameter: <math>\varnothing</math> 4" ~ 6"</p>
GV-Mount410	Pole Mount Bracket Kit ( $\varnothing$ 6" ~ 7.5")		<p>Dimensions</p> <p>Bracket: 241 x 161 mm (9.5" x 6.3")</p> <p>Weight: 1.70 Kg (3.75 lb)</p> <p>Steel Strap Diameter: <math>\varnothing</math> 6" ~ 7.5"</p>
GV-Mount702	Extension Tube		<p>Four options are available.</p> <p>Dimensions:</p> <p><math>\varnothing</math> 5.4 x 10 or 20 or 30 or 50 cm (<math>\varnothing</math> 2.1" x 3.9" or 7.9" or 11.8" or 19.7")</p> <p>Weight:</p> <p>180 g or 390 g or 550 g or 800 g (0.4 lb or 0.86 lb or 1.21lb or 1.76 lb)</p>
GV-Mount900	Wall Mount Bracket		<p>Dimensions: 154 x 108 x 50 mm (6.1" x 4.3" x 2")</p> <p>Weight: 240 g (0.53 lb)</p>
GV-Mount901	GV-VD Series Dome Housing		<p>Dimensions: <math>\varnothing</math> 186 x 97.5 mm (<math>\varnothing</math> 7.3" x 3.8")</p> <p>Weight: 600 g (1.32 lb)</p>
GV-Mount909	Wall Mount Bracket		<p>Dimensions: 170 x 150 x 110 mm (6.7" x 5.9" x 4.3")</p> <p>Weight: 610 g (1.34 lb)</p>
GV-PA191	Power over Ethernet (PoE) Adapter		<p>The GV-PA191 is a Power over Ethernet (PoE) adapter designed to provide power to the IP device through a single Ethernet cable.</p>
GV-Relay V2	GV-Relay V2		<p>The GV-Relay V2 is designed to expand the voltage load of GV IP devices. It provides 4 relay outputs, and each can be set as normally open (NO) or normally closed (NC) independently as per your requirement.</p>

Model No.	Name	Details
Power Adapter		Power adapters are available in 6 regions: Argentina, Australia, Brazil, Europe, U.K and U.S. *This item does not include a power cord.
GV-POE Switch		The GV-POE Switch is designed to provide power along with network connection for IP devices. The GV-POE Switch is available in various models with different numbers and types of ports.